

Product Details

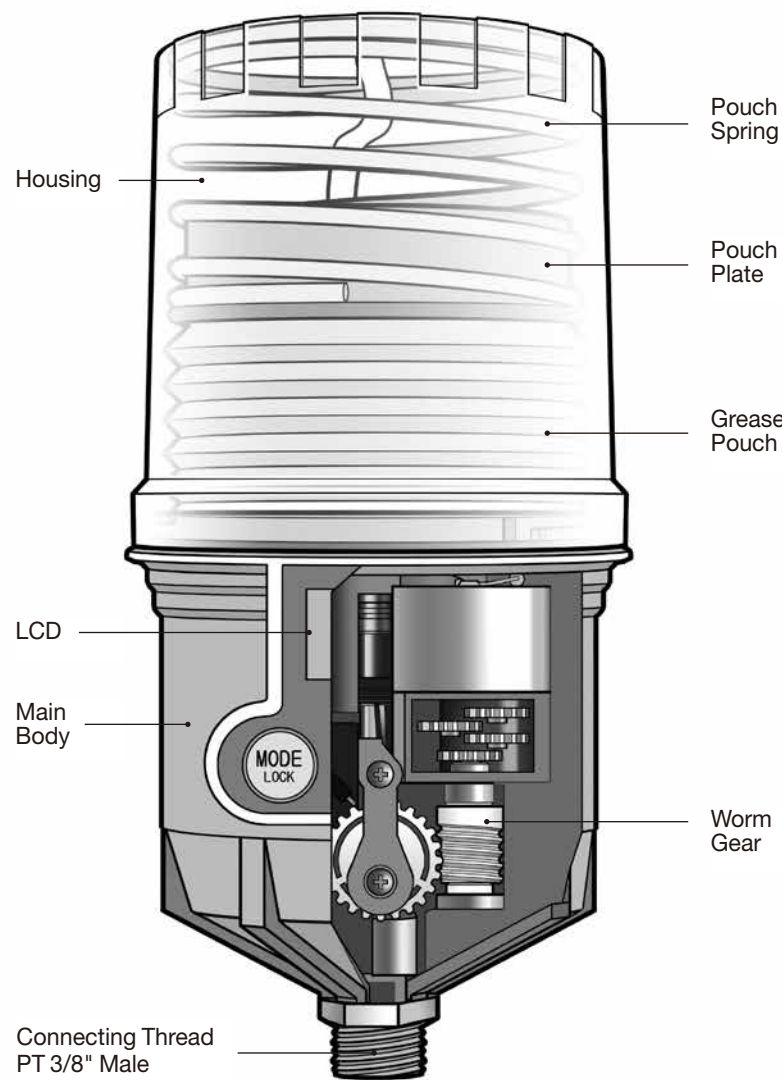

Installation Guidelines

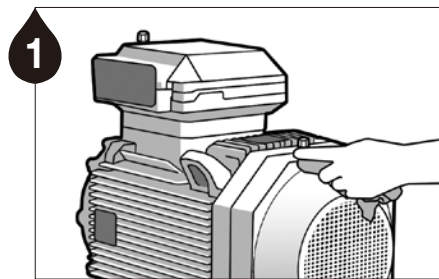

1 Remove contaminants around the lube point.

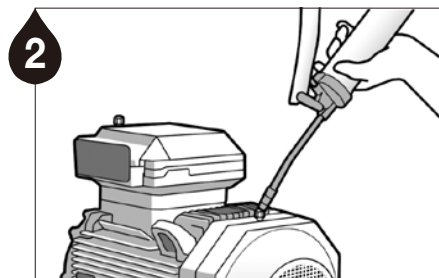

2 Ensure a clear passage using a manual grease gun. **Note1** Remove any hardened grease by purging the lube point with a manual grease gun. **Note2** The grease in the equipment and the grease contained in the unit should be the same or compatible.

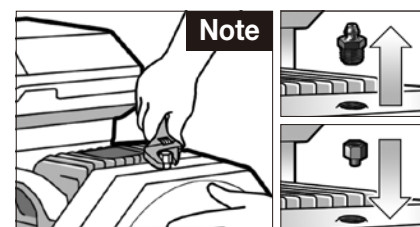

3 Remove the grease nipple and install appropriate adaptors.



4 Check the grease pouch capacity and the service pack items (battery pack, grease pouch & dust cover).

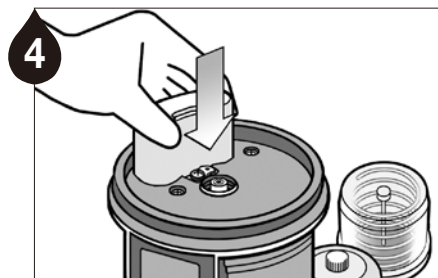

5 Insert battery pack.



6 Purge the grease pouch until grease comes out of the tip.

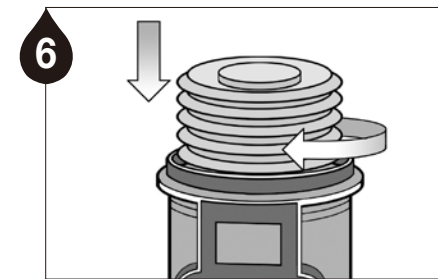

7 Carefully screw the grease pouch in by turning clockwise. Do not over tighten.

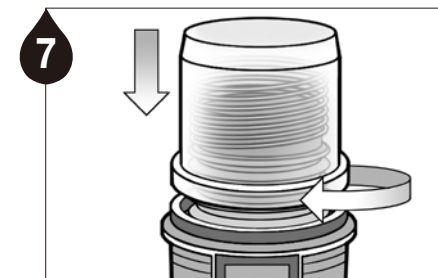

8 Refit the top housing on the unit and turn clockwise until it clicks.

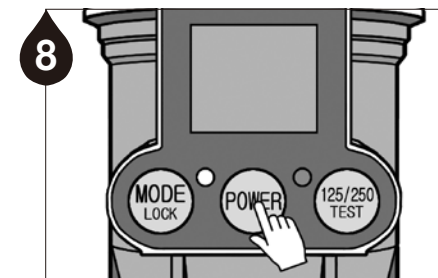

9 Press the POWER button for 2 seconds to turn the unit on.

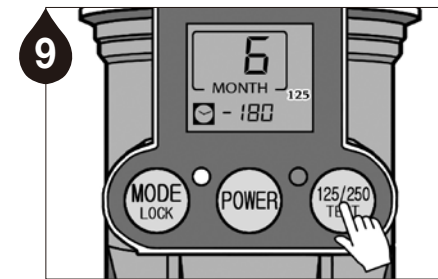

10 Select the appropriate grease pouch capacity by pressing the 125/250/TEST button.

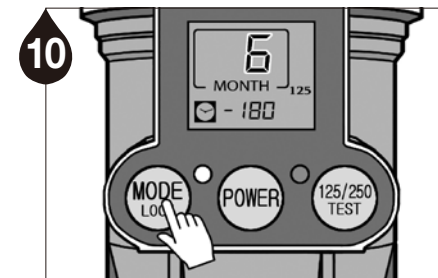

11 Press the MODE button to program the dispensing period.

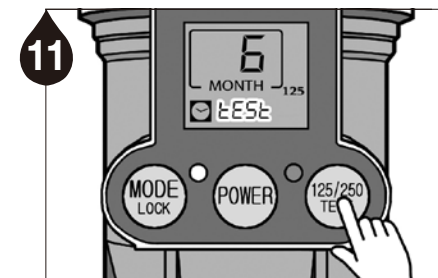

12 Press the TEST button for 2 seconds to run a test cycle and check for proper operation of the unit.

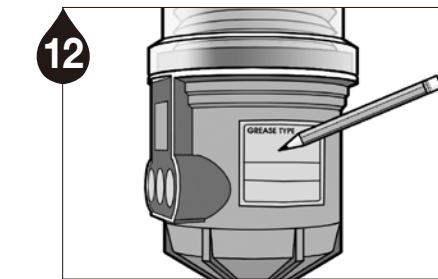

13 Note the installation date and the scheduled completion date of lube cycle on the lubricator using the label provided in the Service Pack for maintenance purposes.

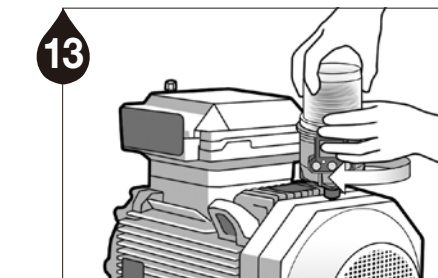

14 Install the PulsarLube M unit on the lube point. When the selected dispensing period has completed, replace the unit with the Service Pack according to step #3-7.

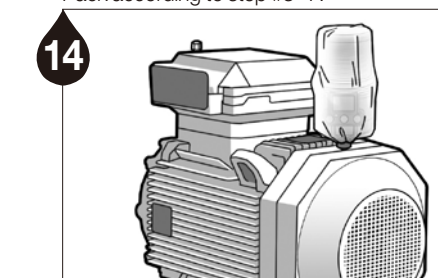

15 Install the dust cover over the lubricator for added protection.

Troubleshooting Guidelines

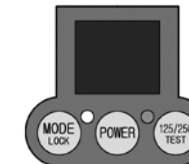

Symptom : Blank LCD screen
Possible Cause : Electrical malfunction of CPU or circuitry, battery problem
Solution : Replace battery pack or press reset button to restart the lubricator. If the problem persists, contact your supplier.

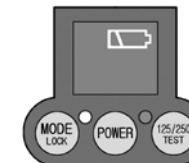

Symptom : Low Battery Indication
Possible Cause : Rapid power consumption due to improper storage or harsh operating conditions (temperature, humidity, or high backpressure).
Solution : Store the battery pack in cool, dry place and choose proper battery type for application. Optional lithium battery pack is available for more advanced applications.

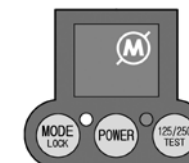

Symptom : Excessive Backpressure Indication
Possible Cause : Excessive backpressure due to hardened grease, over-lubrication, ruptured lube line, long distance remote installation, etc.
Solution : A) Check backpressure at lube point and/or lube line, B) check grease dispensing rate, C) reduce remote installation distance, or D) use manual grease gun to clear blockage.

Button Operation

Dispensing Period

Press to set dispensing period

60ml: 1-12 month
125/250ml: 1, 2, 3, 6, 12 month & 15 days (H)
500ml: 1, 2, 4, 6, 12, 18, 24 month & 15 days (H)

MODE LOCK

Automatic Lock Out Mode

Press for 2 seconds to unlock (🔒)

POWER

Power **ON/OFF**

Press to Power unit On or Off

TEST

Grease Capacity

60ml/500ml

TEST Mode

ON : Press for 2 seconds

OFF : Short press of button

(will stop after completion of ongoing cycle)

125/250 TEST

Grease Capacity

Press to select 125ml/250ml

TEST Mode

ON : Press for 2 seconds

OFF : Short press of button

(will stop after completion of ongoing cycle)

LCD Display



Dispensing period setting

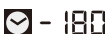

Remaining dispensing days



Automatic Lock Out mode



Grease pouch capacity



TEST mode



Number of days since the cycle ended (📧 and 📧 will also display)

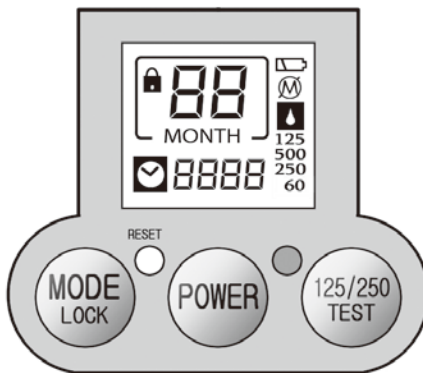

RESET

Reset to default setting when the unit malfunctions and/or after changing the Service Pack



Number of days operation has been on hold due to excessive backpressure



Low battery power



Operation on hold due to excessive backpressure



Empty grease level



LED blinks when battery is low, excessive backpressure exists, or grease level is empty

ISO9001/14001 CE

Mounting Methods

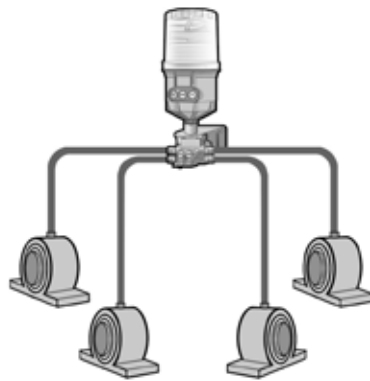
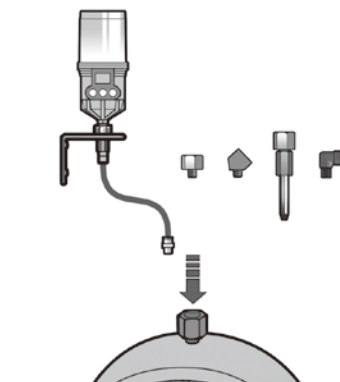

Single Point Installation

Direct Mount or Remote Installation using Extension Tube

Direct mount is always preferable. For applications not allowing any direct mounts, remotely mount the unit using appropriate accessories and keep the distance from the lube point as short as possible.

For remote installation using a tube, use a Ø6 (1/4") tube pre-filled with the same or compatible grease as the grease contained in the unit.

Multi-Point Installation

Multi-Point Remote Installation using Progressive Divider Block (2~8 Points)

Remote multi-point lubrication is available with the Pulsarlube M using a divider block. It is recommended to test the back pressure of the bearing, lube lines, and divider block after assembly using a grease gun connected to a pressure gauge. Ensure the break-off pressure is below the average operating pressure of 30bar (435psi).

⚠ Warning

- ▶ For remote installation, keep the maximum distance at 6m (20ft) or less.
- ▶ Do not plug any open ports on the divider block. The kit or divider block must be ordered with the appropriate number of points required. For more information on the divider block, please refer to the Multi-Point Remote Installation Manual.
- ▶ Use the lithium battery pack for specific applications such as : extremely cold temperature, long period mode setting (18M, 24M), or multi-point remote installation for M 500ml unit.

Shelf life and Product Warranty Warranty is limited to original defects in material and workmanship and will not cover any collateral damage due to mishandling, abuse and /or any other inappropriate use of this product. Warranty period is 1 year from the date of purchase.

Rev.03

PULSARLUBE

The World Leader of Automatic Lubrication

PULSARLUBE

User Manual

Pulsarlube M

Series

(60ml/125&250ml/500ml)

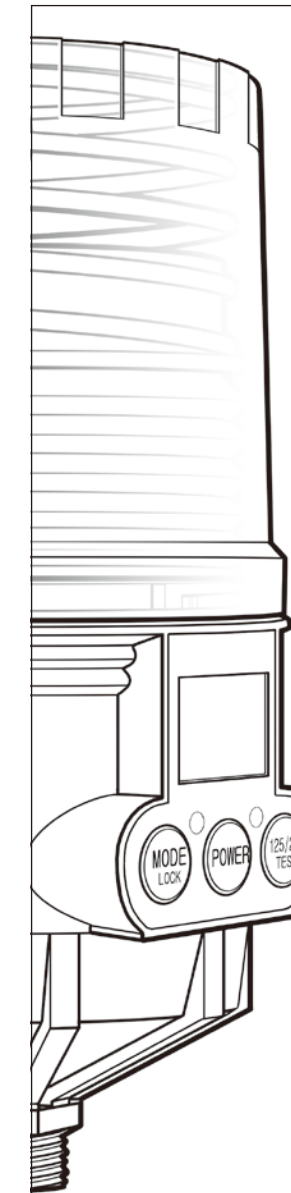

Pulsarlube USA, Inc.

1480 Howard Street, Elk Grove Village, IL 60007, USA

TEL:1-847-593-5300 FAX:1-847-593-5303 www.pulsarlube.com/info@pulsarlube.com